

REV	ECN NO.	DESCRIPTION	DATE	APP'D
C/D		RELEASE TO PRODUCTION		Paul

Features:

- 2 ~ 24 circuits available
- Accepts 4310-00TME series terminal
- 600V volts rating (R.M.S.)
- Current rating up to 9 amperes per circuits
- Positive housing locks
- Max. panel thickness: 2.54mm

Specification:

- Current rating and wire size:

Wire Size AWG	Circuits			
	2	4, 6	8, 10	12~24
# 18	9 A	8 A	7 A	6 A
# 20	7 A	6 A	5 A	5 A
# 22	5 A	4 A	4 A	4 A
# 24	4 A	3 A	3 A	3 A

- Voltage rating: 600V AC, DC
- Insulation resistance: DC 500V 1000MΩ min.
- Dielectric withstanding voltage: 1500V AC/minute
- Ambient temperature range: -40°C ~ 105°C
(including temperature rise)

Ordering Information

P N : 4 3 1 0 - x x H F E

Serial Type

No. of Contact
02~24PIN

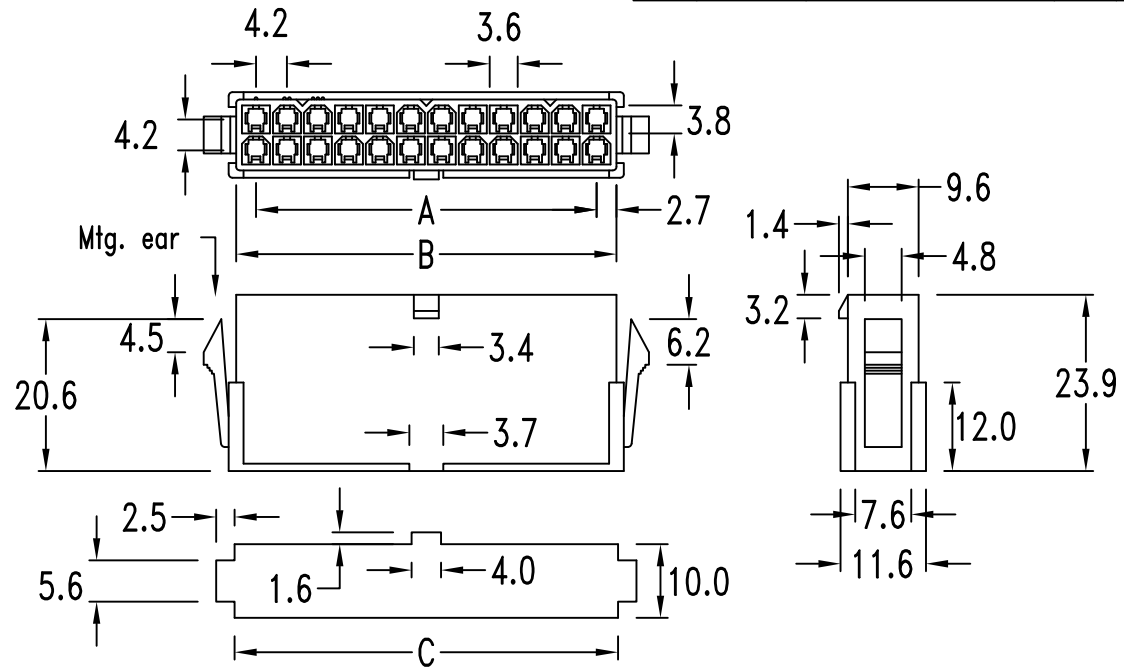

Dimensional Information (mm)

Circuits	Dim. A	Dim. B	Dim. C	Circuits	Dim. A	Dim. B	Dim. C
2		5.6	5.8	14	25.2	30.8	31.0
4	4.2	9.8	10.0	16	29.4	35.0	35.2
6	8.4	14.0	14.2	18	33.6	39.2	39.4
8	12.6	18.2	18.4	20	37.8	43.4	43.6
10	16.8	22.4	22.6	22	42.0	47.6	47.8
12	21.0	26.6	26.8	24	46.2	51.8	52.0

TOLERANCE	APPROVALS	DATE	易昕企業有限公司 LEAMAX ENTERPRISE CO., LED.		
.000 ± 0.08 (mm) .00 ± 0.25 (mm) .0 ± 0.4 (mm)	DRAWN Daniel	05-01-15	TITLE: .165*(4.2mm) Plug Housing		
	CHK'D Huang	01-06-15			
	APP'D Chen	12-06-15	DWG NO.4310-HFB		
UNTS mm		SCALE 1:1	SIZE:A4	SHEET 1 OF 2	REV. C/D

REV	ECN NO.	DESCRIPTION	DATE	APP'D
C/D		RELEASE TO PRODUCTION		Paul

2P

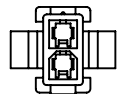

4P

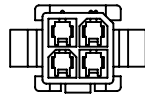

6P

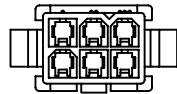

8P

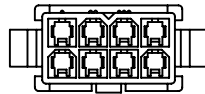

10P

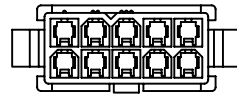

12P

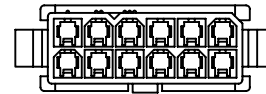

14P

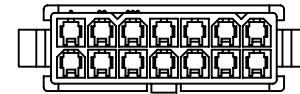

16P

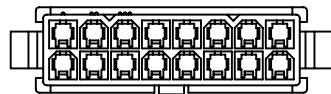

18P

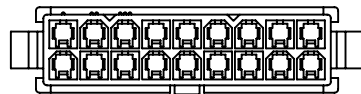

20P

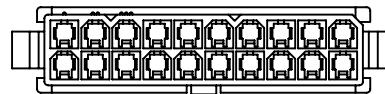

22P

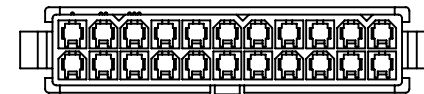

24P

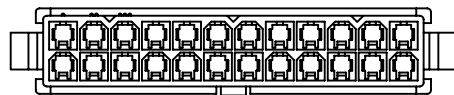

Ordering Information

P N : 4 3 1 0 - x x H F E

Serial Type

No. of Contact
02~24PIN

TOLERANCE .000 ± 0.08 (mm) .00 ± 0.25 (mm) .0 ± 0.4 (mm)	APPROVALS	DATE	 易昕企業有限公司 LEAMAX ENTERPRISE CO., LED.		
	DRAWN Daniel	05-01-15			
	CHK'D Huang	01-06-15	TITLE: .165"(4.2mm) Plug Housing		
	APP'D Chen	12-06-15	DWG NO.4310-HFB		
	UNTS mm	SCALE 1:1	SIZE:A4	SHEET 2 OF 2	REV. C/D